

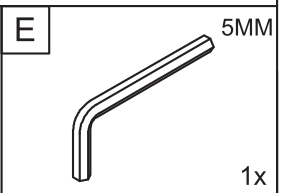

TULIP

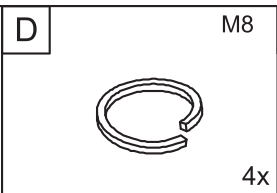

I

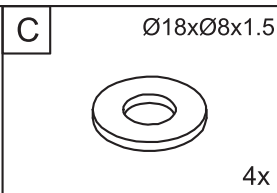
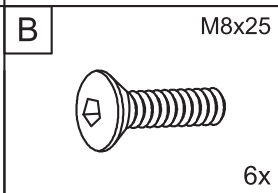
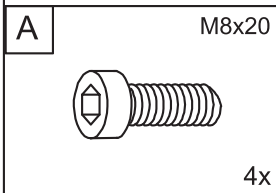
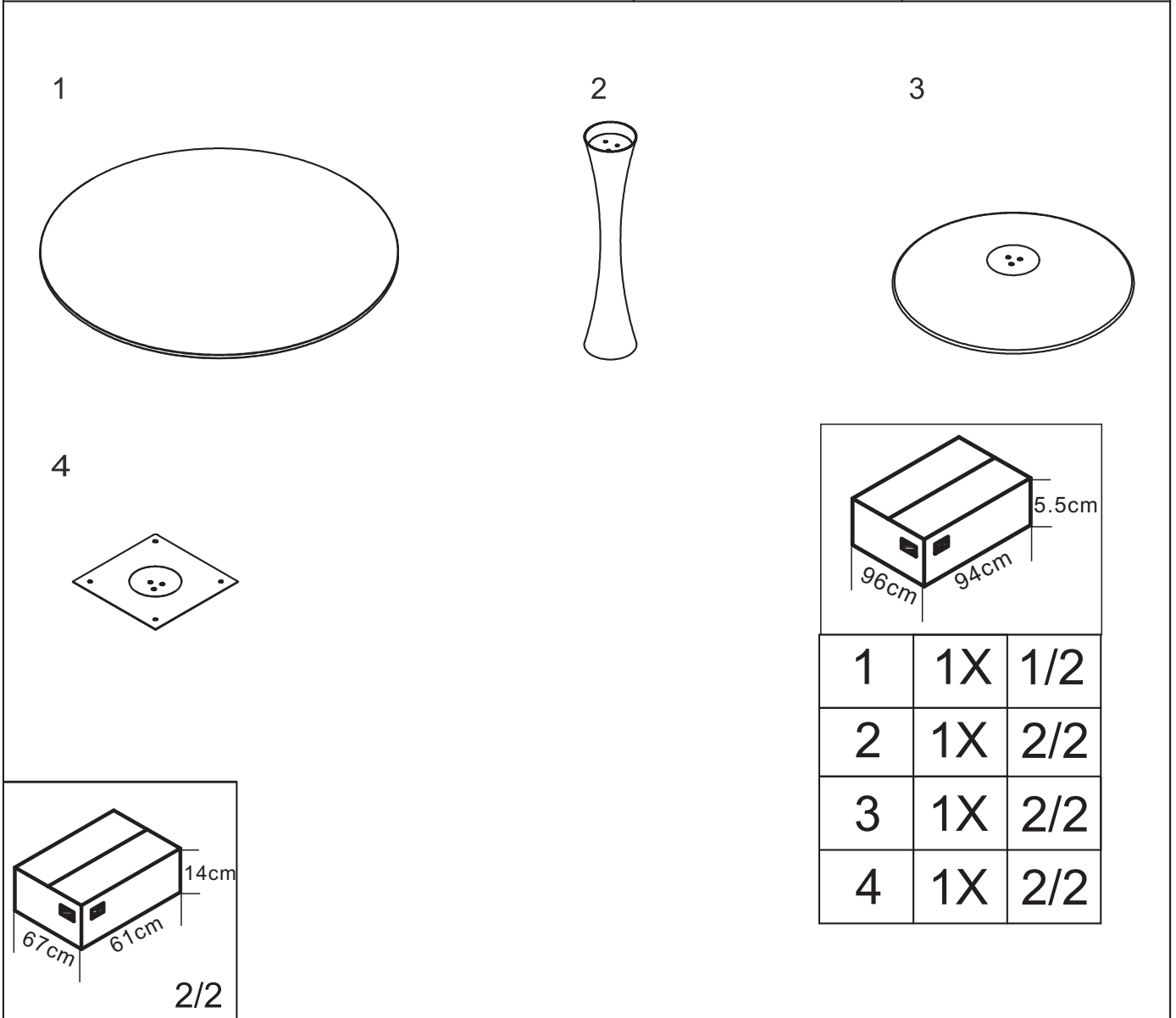
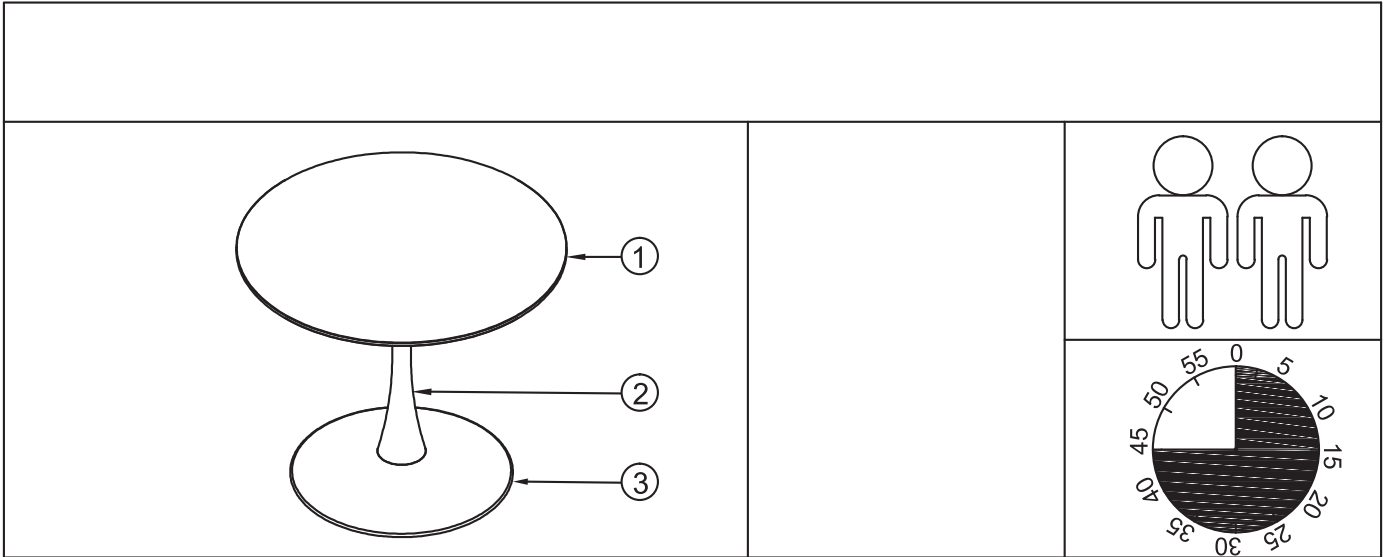
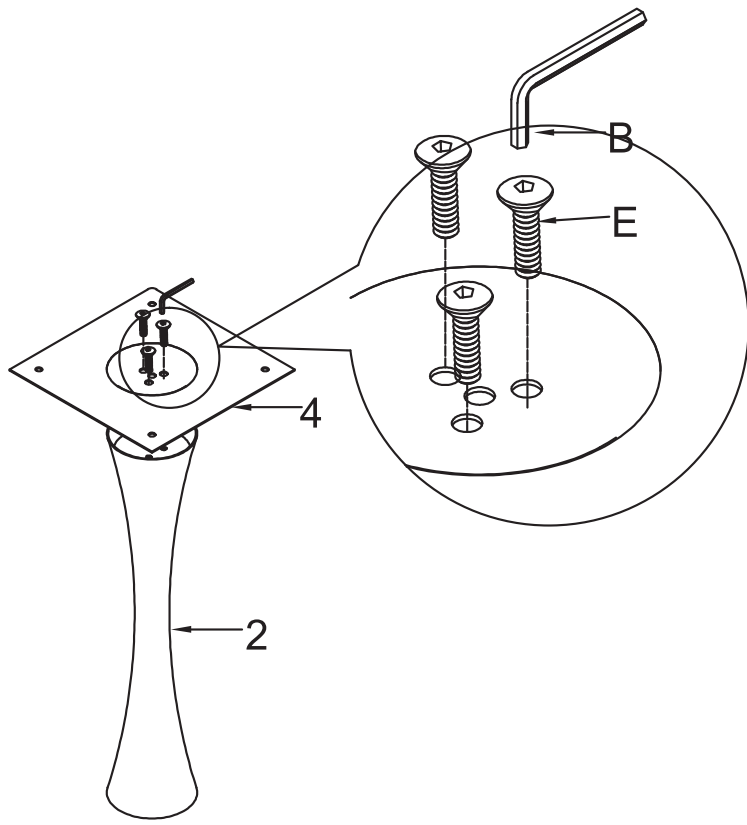

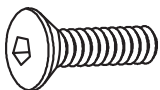
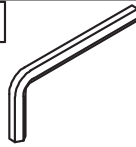

1

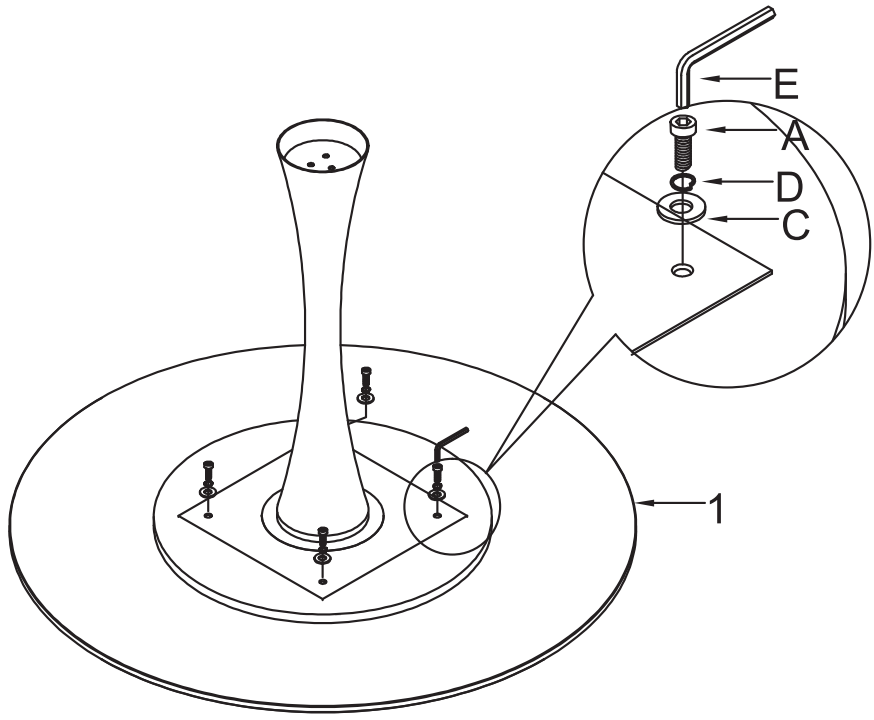

- B M8x25
 3x
- E 5MM
 1x
- 

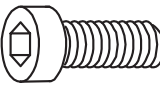
2

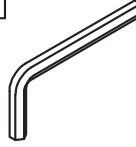



- A M8x20
 4x
- C Ø18xØ8x1.5
 4x
- D M8
 4x
- E 5MM
 1x
- 

II.

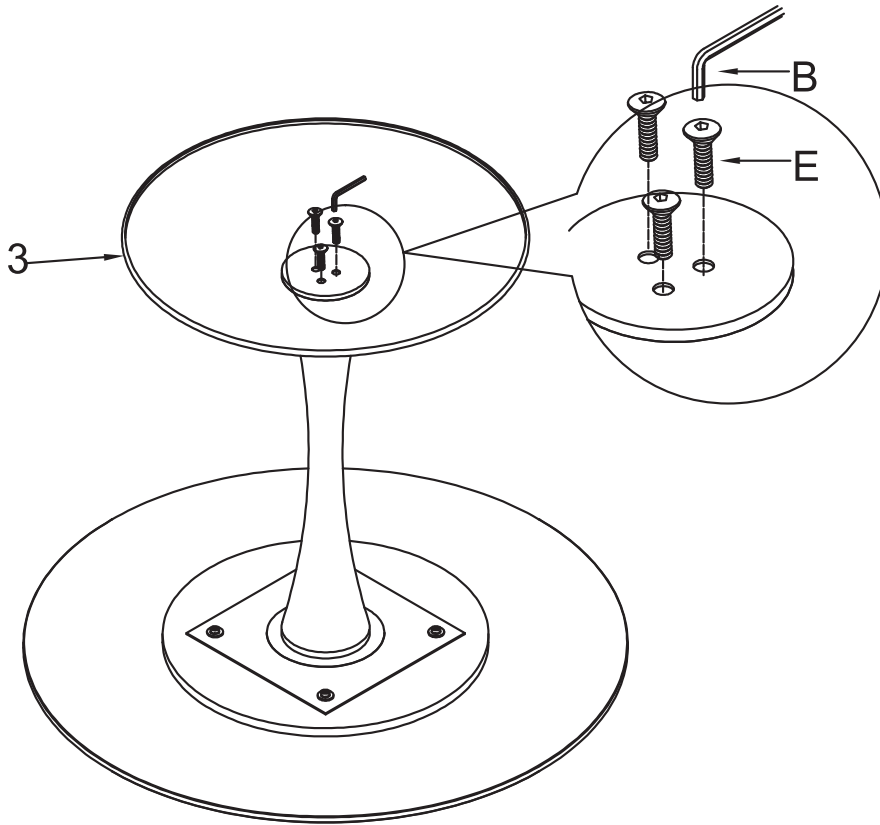
3

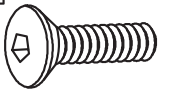
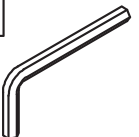
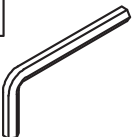

B	M8x25	
E	3x 5MM	
	1x	
		

4

